

36950

Rectangular Porcelain Undermount Bathroom Basin

21 1/8" x 14 5/8" x 8"

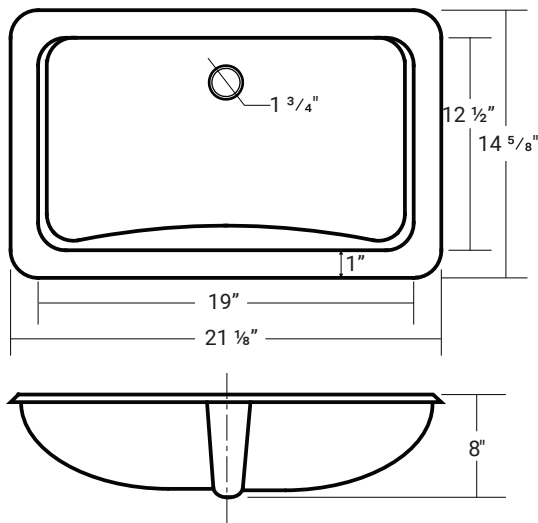

COUNTERTOP CUT-OUT:

It is recommended that the hole for the sink be cut 1/2" x 1/2" smaller than the inside bowl dimensions.

Important

*While we strive to provide accurate measurements for our customers, sometimes mistakes happen. Our goal is to help things run smoothly from shipment to installation, so if you notice any errors in our spec sheets, please let us know.

Our products are handmade & hand finished so you can expect a tolerance of ± 1/4" on all measurements. We strongly recommend waiting until your ordered product is on-site before attempting any rough-in carpentry or plumbing.

If you want to verify any of our measurements, please feel free to call or email us.

*Drawings are not to scale



Product Specifications

- Available in white
- Rectangular bowl with a curved bottom.
- Overflow located at the front of the sink.
- Drain not included
- Net sink weight: 22 lbs.
- Minimum cabinet size required: 24"
- Allow sufficient space for a faucet (not included).
- Installation brackets sold separately. Item # 04000.
- 1 year limited manufacturer's warranty included.

Design Features

- Cast to ensure exceptional strength as well as long term durability.
- Forged from a proprietary blend of clays to create an ideal product for new homes or bathroom renovations.
- Unique, easy-to-clean coating helps to seal the sink against bacteria and microbes and provides a durable gloss finish.

Acritec Industries Corp.

27049 Gloucester Way
Langley, B.C. V4W 3Y3

Tel: 604.607.0856

Fax: 604.607.0857

Email: info@acritec.com

Website: www.acritec.com

In keeping with our policy of continuing product improvement, Acritec Industries Corp. reserves the right to change product specifications without notice.