

21140

Undermount

29 1/2" x 19 1/4" x 8"

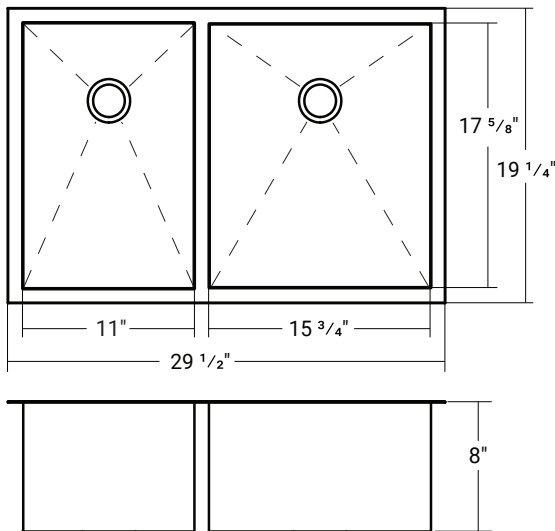
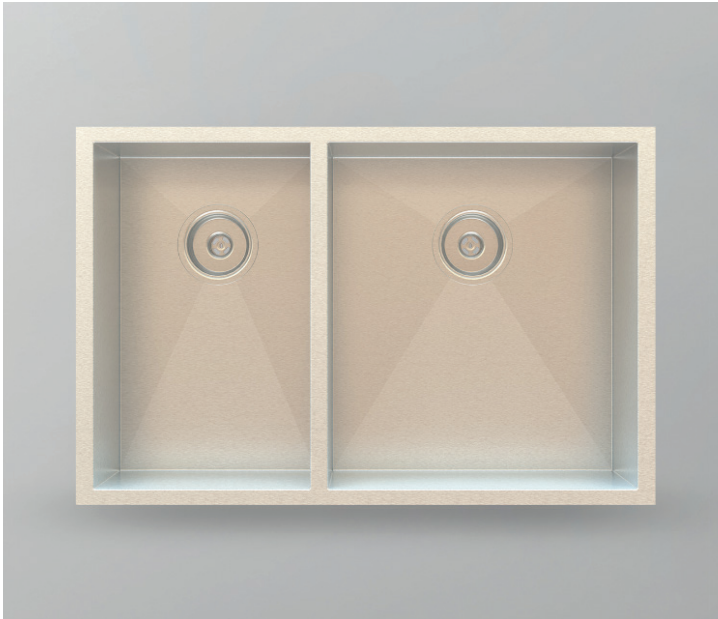

COUNTERTOP CUT-OUT:

It is recommended that the hole for the sink be cut 1/2" x 1/2" smaller than the inside bowl dimensions.

Important

*While we strive to provide accurate measurements for our customers, sometimes mistakes happen. Our goal is to help things run smoothly from shipment to installation, so if you notice any errors in our spec sheets, please let us know.

Our products are handmade & hand finished so you can expect a tolerance of ± 1/4" on all measurements. We strongly recommend waiting until your ordered product is on-site before attempting any rough-in carpentry or plumbing.

If you want to verify any of our measurements, please feel free to call or email us.

*Drawings are not to scale



Product Specifications

- Fabricated from type 304, 18 gauge stainless steel.
- Constructed from 18/9 chrome/nickel content stainless steel for durability and superior longevity.
- Net sink weight: 20 lbs.
- Minimum cabinet size required: 33"
- Allow sufficient space for the faucet.
- Included with sink:
 - 3 1/2" stainless steel strainer(s)
 - Installation clamps
 - Cut-out template
- 1 year limited manufacturer's warranty included.

Design Features

- Resilient and easy-to-clean Brushed Satin finish.
- Double bowls with squared corners.
- Installation clamps provided for quick & easy installation.
- Large polymer sound deadening pads minimize sounds and vibrations
- 3 1/2" drain opening.

Acritec Industries Corp.

27049 Gloucester Way
Langley, B.C. V4W 3Y3

Tel: 604.607.0856

Fax: 604.607.0857

Email: info@acritec.com

Website: www.acritec.com

In keeping with our policy of continuing product improvement, Acritec Industries Corp. reserves the right to change product specifications without notice.