



Simplicity Wood Panel 6030

Product # LH: 41389.02010 | RH: 41390.02010

59 7/8" x 30" x 22 1/2" | Immersion Depth: 14 5/8"

Product Specifications

- 100% Acrylic with fiberglass & wood reinforcement
- Factory installed integral wood apron for tile application
- Integral tiling flange
- Leveling feet included
- Backrest angle: 118°±2°
- End drain
- Drain hole: 2"
- Water capacity: approx. 53 US gallons
- 1 Year limited manufacturer's warranty included

Design Features

- Available in both left hand & right hand
- Above floor rough-in compatibility

Available Upgrades

- Water and or air jetting system
- Comfortwarm™ heated lumbar/backrest
- Chromotherapy
- Vibe Sound
- Aromatherapy

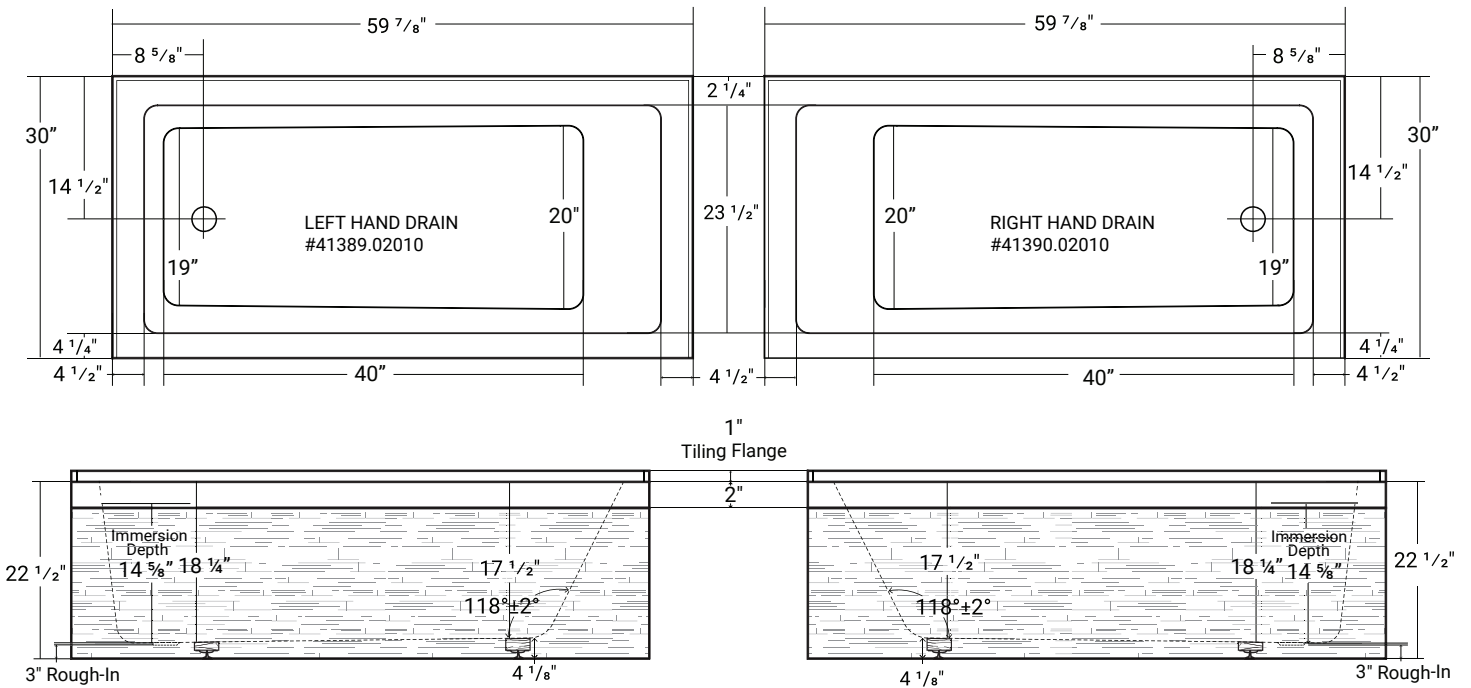

Acritec Industries Corp.

27049 Gloucester Way
Langley, B.C. V4W 3Y3

Tel: 604.607.0856

Fax: 604.607.0857

Email: info@acritec.com

Website: www.acritec.com

In keeping with our policy of continuing product improvement, Acritec Industries Corp. reserves the right to change product specifications without notice.

Important

*While we strive to provide accurate measurements for our customers, sometimes mistakes happen. Our goal is to help things run smoothly from shipment to installation, so if you notice any errors in our spec sheets, please let us know.

Our products are handmade & hand finished so you can expect a tolerance of ± 1/4" on all measurements. We strongly recommend waiting until your ordered product is on-site before attempting any rough-in carpentry or plumbing.

If you want to verify any of our measurements, please feel free to call or email us.

*Drawings are not to scale

