

# 30085

## Composite (Pure) Countertop

30 1/2" x 22 1/8" x 3 5/8"



### Design Features

- Seamless solid surface composite construction formulated from a blend of natural and synthetic materials.
- Non-porous surface is anti-bacterial and easy to clean as well as impact, scratch and stain resistant
- Designed for above counter installation.
- Flat bottom, single centered rectangular bowl.
- 1 year limited manufacturer's warranty included

### Product Specifications

- Generous rear faucet deck
- Faucet & drain not included
- Overflow included at back of bowl
- Available with a finished or non-finished back.

### Pre-Drilled Faucet Holes

- Single Hole Centered: Add ("-01" to part number)
- 3 Holes @ 4": Add ("-04" to part number)
- 3 Holes @ 8": Add ("-08" to part number)

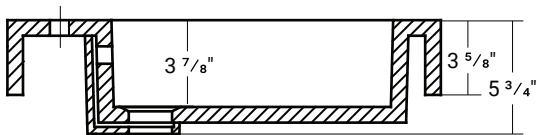
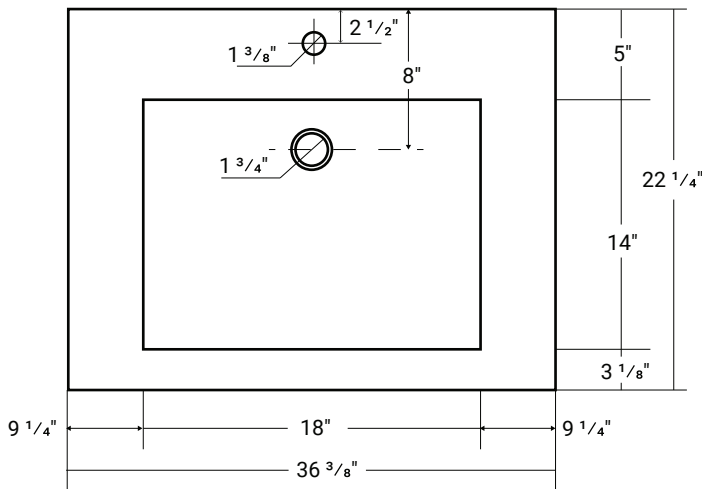

#### Important

\*While we strive to provide accurate measurements for our customers, sometimes mistakes happen. Our goal is to help things run smoothly from shipment to installation, so if you notice any errors in our spec sheets, please let us know.

Our products are handmade & hand finished so you can expect a tolerance of ± 1/4" on all measurements. We strongly recommend waiting until your ordered product is on-site before attempting any rough-in carpentry or plumbing.

If you want to verify any of our measurements, please feel free to call or email us.

\*Drawings are not to scale



#### Acritec Industries Corp.

27049 Gloucester Way  
Langley, B.C. V4W 3Y3

**Tel:** 604.607.0856

**Fax:** 604.607.0857

**Email:** info@acritec.com

**Website:** www.acritec.com

In keeping with our policy of continuing product improvement, Acritec Industries Corp. reserves the right to change product specifications without notice.