

36428

16 1/8" x 16 1/8" x 5 1/2"



Product Specifications

- Circular Bowl Shape
- Designed for counter-top installation
- Drain hole 1 3/4"
- Net sink weight: 18 lbs
- Finished on all sides
- Faucet & drain not included
- 1 Year limited manufacturer's warranty included

Design Features

- Cast to ensure exceptional strength as well as long term durability
- Forged from a propriety blend of clays to create an ideal product for new homes or bathroom renovations
- Unique, easy-to-clean coating helps to seal the sink against bacteria and microbes and provides a durable gloss finish

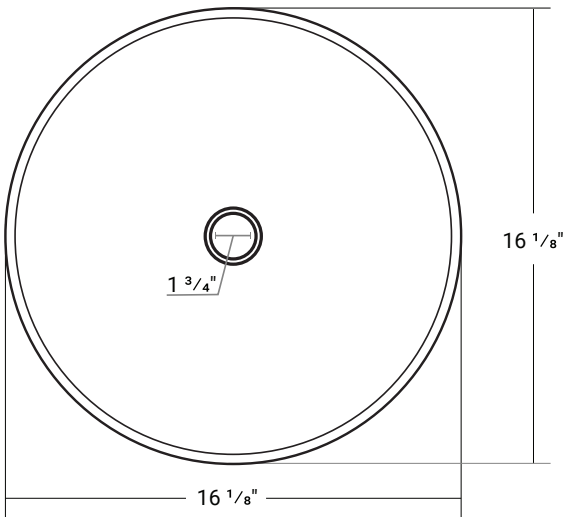

Important

*While we strive to provide accurate measurements for our customers, sometimes mistakes happen. Our goal is to help things run smoothly from shipment to installation, so if you notice any errors in our spec sheets, please let us know.

Our products are handmade & hand finished so you can expect a tolerance of $\pm 1/4$ " on all measurements. We strongly recommend waiting until your ordered product is on-site before attempting any rough-in carpentry or plumbing.

If you want to verify any of our measurements, please feel free to call or email us.

*Drawings are not to scale



Acritec Industries Corp.

27049 Gloucester Way
Langley, B.C. V4W 3Y3

Tel: 604.607.0856

Fax: 604.607.0857

Email: info@acritec.com

Website: www.acritec.com

In keeping with our policy of continuing product improvement, Acritec Industries Corp. reserves the right to change product specifications without notice.